

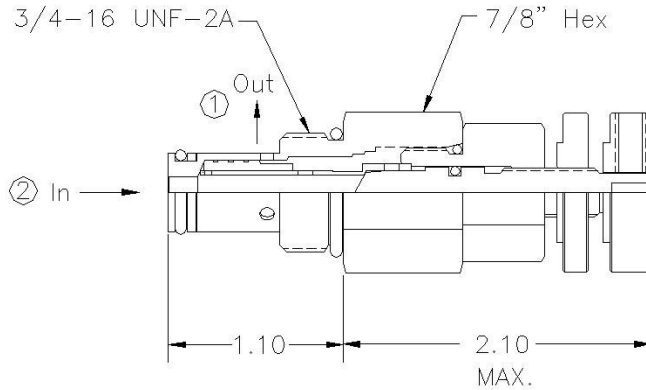

1322.00

Flow Control Valve

Pressure Compensated
Adjustable
Stainless Steel
8 gpm
C08-2 Cavity

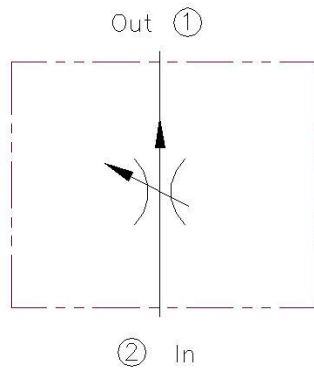

Operation Controls flow from the port 2 to port 1 at an adjusted value over a varying pressure range. Reverse flow is restricted and not compensated.

Type Adjustable pressure compensated flow control.

Material External parts of stainless steel. Internal parts are precision ground & honed, hardened steel parts. Buna-N seals standard.

Maximum Pressure 5,000 psi (350 bar)

Flow Adjustable range from 1 to 8 gpm

Fluid General hydraulic fluid

Cavity C08-2

Install torque 20 lb-ft (27Nm)

Options

1322.00 - 8 - K N
 Basic cartridge Adjustment Range 8 - 1 to 8 gpm Adjustment Type L - Screw Adjustment K - Knob Adjustment T - 'T'-Handle Seals N - Buna-N V - Viton

